

Desoldering tip tunnel 9.6 x 15 mm, C245304

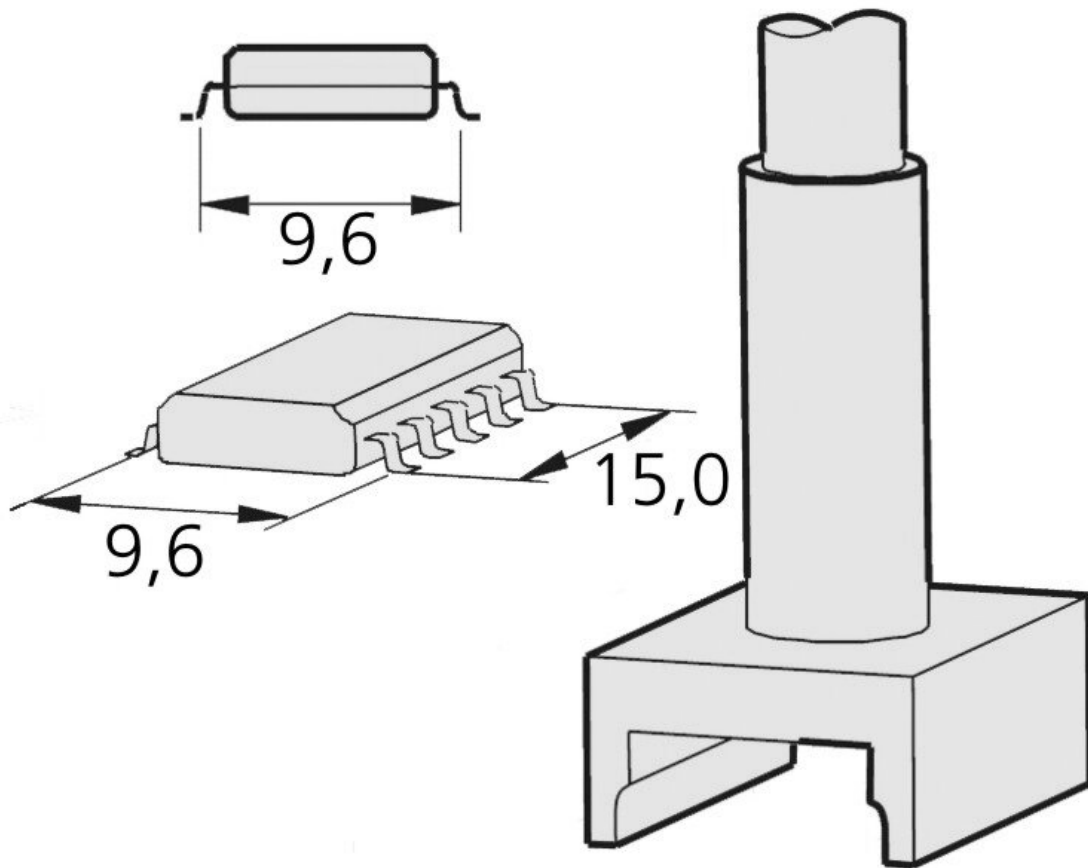

SMD Desoldering Tip Series C245 for Soldering Iron T245 (formerly AD-2245)

Item no.	WL22508
Model	C245-304
Manufacturer	JBC
Manufacturer article no.	C245304
GPSR manufacturer data	JBC Soldering SL Ramón y Cajal 3 ES-08750 Molins De Rei www.jbctools.com
Length with packaging	110 mm
Width with packaging	12 mm

Height with packaging	12 mm
Sales unit	1 piece
Content unit	1 piece
Incl. battery	no
Product series	C245
Tip series	C245
Incl. integrated heating	yes
Total length of the soldering tip	120 mm
Tip applications	for dual-in-line IC 15 x 9.6 mm
Tip shape	special form
Tip alignment	straight
Suitable soldering iron	T245
Matching handpiece	T245
Matching handpiece	T245
ESD compliant	no